

DESCRIPTION

The PUP180N3 series of AC/DC switching power supplies are for 180 watts of continuous output power. They are enclosed in a 94V-0 rated plastic case with an inlet of the IEC320/C14 or IEC320/C6 to mate with interchangeable cord for world-wide use. All models meet EN55032 and FCC class B emission limits, and comply with UL, CSA, IEC and CE requirements.

FEATURES

- No load power consumption less than 0.15 W
- Compliant with DoE level VI requirements
- Meet Energy Star EPS2.0 /ErP EC No 278/2009 (Lot 7)
- Meet EU CoC EPS V5 Tier 2
- Operating altitude up to 5000 meters
- Overvoltage protection (latch)
- Short-circuit protection (auto-recovery)
- Overpower protection (auto-recovery)
- Over temperature protection (latch)
- High Efficiency $\geq 89\%$
- With PFC circuit
- 100% burn-in at full rated load
- Compliant with RoHS requirements

INPUT SPECIFICATIONS

Input voltage:	90-264 VAC
Input frequency:	47-63 Hz
Input current:	1.8 A (rms) for 115 VAC 0.9 A (rms) for 230 VAC
Earth Leakage current:	250 μ A max. @ 264 VAC, 60 Hz

OUTPUT SPECIFICATIONS

Output voltage /current:	See rating chart.
Maximum output power:	See rating chart.
Ripple and noise:	350 mV peak to peak maximum
Overvoltage protection:	Set at 125-155% of its nominal output voltage
Overcurrent protection:	All models protected to short circuit conditions (auto-recovery)
Temperature coefficient:	All outputs $\pm 0.04\%$ / $^{\circ}$ C maximum
Transient response:	Maximum excursion of 4% or better on all models, recovering to 1% of final value within 500 μ s after a 25% step load change

ENVIRONMENTAL SPECIFICATIONS

Operating temperature:	0 $^{\circ}$ C to +40 $^{\circ}$ C
Storage temperature:	-20 $^{\circ}$ C to +80 $^{\circ}$ C
Operating humidity:	20% to 80% non-condensing
Storage humidity:	10% to 90% non-condensing
Temperature derating:	Derate from 100% at +40 $^{\circ}$ C linearly to 50% at +60 $^{\circ}$ C

PUP180N3 SERIES



SAFETY STANDARD APPROVALS



UL 62368-1, CSA C22.2 No. 62368-1
File No. E190414



TÜV EN 62368-1

GENERAL SPECIFICATIONS

Hold-up time:	10 ms minimum at 100 VAC
Turn on delay time:	3 s maximum at 100 VAC
Power factor:	0.95 typical
Efficiency:	89% minimum at 110 VAC or 240 VAC.
Line regulation:	$\pm 0.5\%$ maximum at full load
Inrush current:	100 A @ 115 Vac or 200 A @ 230 Vac at 25 $^{\circ}$ C cold start
Withstand voltage:	4242 VDC from input to output 2500 VDC from input to ground
MTBF:	200,000 hours at full load at 25 $^{\circ}$ C ambient, calculated per SR332
EMC Performance	
EN55032:	Class B conducted, Class B radiated
EN61000-3-2:	Harmonic distortion, Class D
EN61000-3-3:	Line flicker
EN55035	
EN61000-4-2:	ESD, ± 8 KV air and ± 4 KV contact
EN61000-4-3:	Radiated immunity, 3 V/m
EN61000-4-4:	Fast transient/burst, ± 1 KV
EN61000-4-5:	Surge, ± 1 KV diff., ± 2 KV com.
EN61000-4-6:	Conducted immunity, 3 Vrms
EN61000-4-8:	Magnetic field immunity, 1 A/m
EN61000-4-11:	Voltage dip immunity, 30% reduction for 500 ms, and >95% reduction for 10 ms

OUTPUT VOLTAGE/CURRENT RATING CHART

Model ⁽¹⁾	Output						Average Active efficiency (typical) @ 115 / 230 Vac
	V1	Min. Current	Max. Current	Tol.	Ripple & Noise ⁽²⁾	Max. Power	
PUP180N3-13-2	19 V	0 A	9.47 A	±5%	350 mV	180 W	89 /91%
PUP180N3S-13-2	19 V	0 A	9.47 A	±5%	350 mV	180 W	89 /91%
PUP180N3-14	24 V	0 A	7.50 A	±5%	350 mV	180 W	90 /92%
PUP180N3S-14	24 V	0 A	7.50 A	±5%	350 mV	180 W	90 /92%
PUP180N3-19	54 V	0 A	3.34 A	±5%	350 mV	180 W	91 /93%
PUP180N3S-19	54 V	0 A	3.34 A	±5%	350 mV	180 W	91 /93%

NOTES:

- PUP180N3 models are equipped with IEC320/C14 inlet, and PUP180N3S models are equipped with IEC320/C6 inlet.
- Ripple and noise is maximum peak-to-peak voltage value measured at output within 20 MHz bandwidth, at rated line voltage and output load ranges, and with a 47 µF tantalum capacitor in parallel with a 0.1 µF ceramic capacitor across the output.

MECHANICAL SPECIFICATIONS

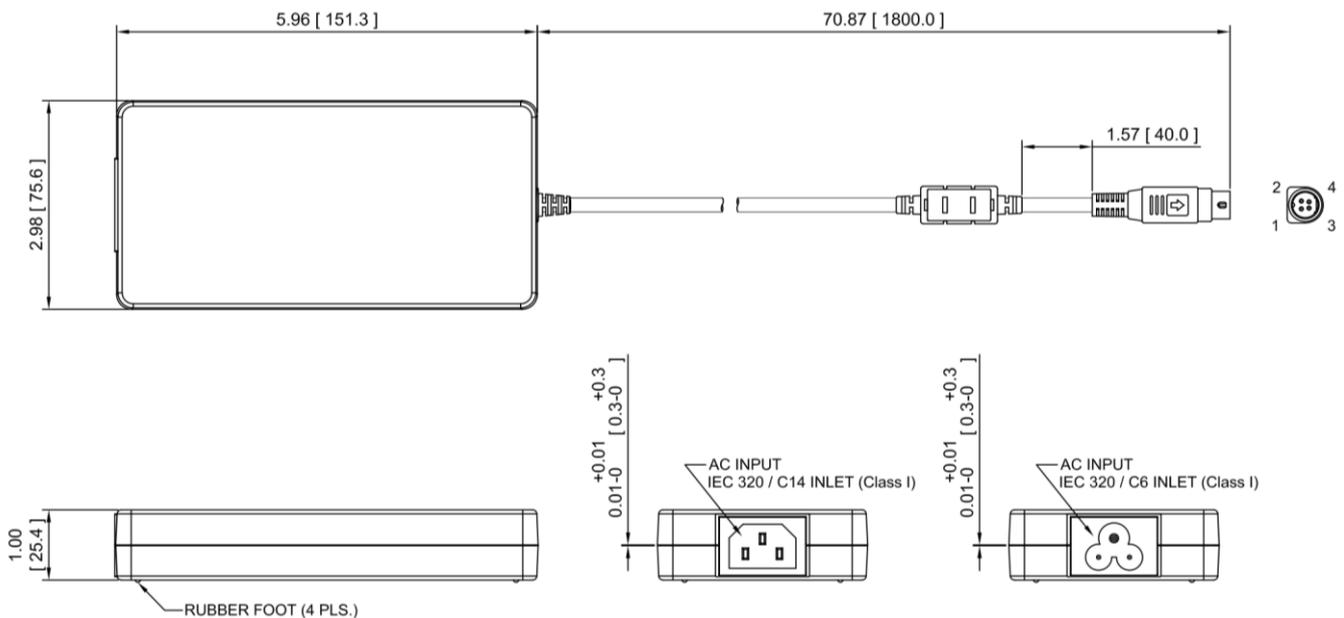

NOTES:

- Dimensions shown in inches [mm]
- Tolerance 0.02 [0.5] maximum
- Weight: 428 grams (0.95 lbs.) approx.
- V1 return (-) is electrically connected to incoming Earth Ground through 1K ohm resistor as standard.

PIN CHART

PIN NO.	1	2	3	4	SHELL OF CONNECTOR
Polarity	+V1	+V1	V1 Return	V1 Return	V1 Return